



A Training Program on Mathematics Online Communication Skills to Overcome Barriers in Communicating Mathematics through Internet

Dr. Randa Elsheikh Najdi



Received: 15/1/2017, Accepted: 25/5/2017.
Assistant Professor/ Al-Quds Open University/ Palestine

Introduction

Communication is the heart of education as instructors and students communicate all the time. The paths of communication are numerous, yet they could be the source of many problems. One critical area of interest is the communication that takes place between students and their instructors, since instructors are the key players involved in the normal day-to-day operations of education. Students' and instructors' abilities to effectively communicate cannot be overstated. Communication is the process of sharing ideas, information, and messages with others; it includes verbal and nonverbal communication such as talking and writing. It could be online or offline, and of course online communication is considered a vital part of recent educational life (Hamer: 2005).

Online communication is gaining popularity among scholars as an important medium to deliver instructional materials in the academic world. It has an important impact on shaping the role of educators and students. It provides a pedagogical context of learning that has shown to have positive effects on students' understanding, and higher-order thinking skills. Researchers have confirmed that the increasing prevalence of the internet and other online services in higher education urge for having good quality of communications throughout all subjects, especially in Math and Science (Portela: 2007). NCTM emphasized that an effective online math communication using

good vocabulary and notations is important (NCTM Standards: 2000); Writing mathematics language using notations can help students consolidate, reflect and clarify their own work (Mojibur: 2010).

Communication is the mean by which ideas are shared, and a vehicle for clarifying and understanding (NCTM Standards: 2000). Writing mathematics language using notations can help students consolidate, reflect and clarify their own work (Mojibur: 2010), when designing math courses.

In the 21st century, the new generation is growing up with technology, which dramatically changes how the educational learning process is provided.

Instructors and students need to be aware of the importance of improving their educational technological tools and skills to be able to communicate effectively without misunderstanding and confusion. Effective communication promotes an awareness of others interests and needs. Being aware of the necessary skills will encourage communication when working with others.

A basic communication model consists of six components: the sender and receiver, the medium that carries the message, the message, and the feedback. To target your messages effectively, you need to consider the variables that can affect each of the components in the model. Following are the components of communication essentially training model indicated schematically in Fig. 1

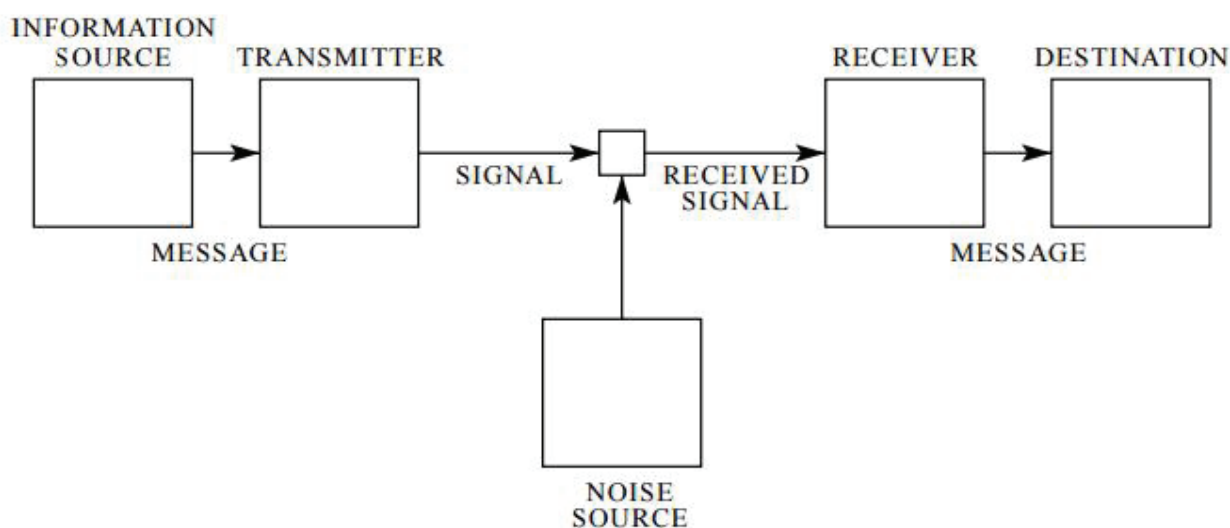

Fig. 1—Schematic diagram of a general communication system.

Sender: An information source which produces a message or sequence of messages to be communicated to the receiving terminal.

Message: a communication in speech, writing, or written signals. The terminology used in a message may act as a barrier if it is not fully understood by the receiver(s).

Transmitter: which operates on the message in some way to produce a signal suitable for transmission over the channel, the message must be sampled, compressed, quantized and encoded, and finally interleaved properly to construct the signal.

Medium: The channel is merely the medium used to transmit the signal from transmitter to receiver.

Receiver: The receiver ordinarily performs the inverse operation of that done by the transmitter, reconstructing the message from the signal.

Feedback: It is the response of the receiver to sender's message (Feldman:2005)

The Importance of Communication in Education

Students need to begin the process of improving their communication skills with a frame of mind based on effort, persistence, and self-correction (fragment sentences). Students need to speak in public by first having conversations, then by answering questions and expressing their opinion in class, and finally by preparing and delivering speeches (Schmitz, Andy (2012). Sherwyn (2008) noted three major themes that provide support for communication in education, these themes include the following:

- **The development of the whole person**

This theme suggests that communication plays a key role in self-development by enhancing relationships with one's self, others, and society. It also suggests that communication is vital to the development of skills and sensitivities that shape our social and political lives, help society's positive continuance, and erase cultural boundaries.

- **The improvement of the educational enterprise**

This theme suggests that communication enhances the quality of classroom instruction and is a key to successful collaboration in educational environments.

- **The interaction**

This theme suggests that communication

skills are fundamental to educational success, since interaction between members of the teaching - learning process plays an important role in the development of the educational concepts among students through persuasion and conviction. The key to a good communication is to convey meaning as accurate and concise manner as possible. The sloppy correspondence style reflects a lack of professionalism, and the good use of language in communication in the modern world is essential, and it is becoming ever more so as we participate in what is now commonly called the information age.

The Importance of Mathematical Communication

Mathematical communication is an essential process for learning math because through communication, students reflect upon, clarify and expand their ideas and understanding of math relationships and math arguments. (Ontario Ministry of Education, 2005). Math Communication enables students to think about and articulate what they know. Math writing also provides evidence of students' math understanding. The quality of a written product is significantly important to participate in a class dialogue ((Ontario Ministry of Education, 2006). Furthermore, written math communication includes writing questions, explaining problems, defining concepts, discussing arguments, proving theories, justifying answers, and defending solutions. When students participate in these actions in an active, focused, and purposeful way, they are furthering their understanding of math.) (Ontario Ministry of Education, 2006, p. 66).

Written math communication has its own language, it is concisely described by Drouhard (2004) as symbolic expressions and compound representations, such as diagrams and tables which usually contain notations or symbols which can be thought of in three categories: letters

($\mathcal{E}, \pi, \Delta, \psi, n \sum a^{n-t} x^t$), other figures ($(,), \{, \}, \oplus, \approx$)

and graphs.

Mathematical Communication in Online Courses

When technologies are used in Math education, it is important to assess how activities will support the development of Mathematical understanding and the technical expertise that students will need (Foster: 2006). Effective Mathematical communication

within the traditional theme can be a challenge but when go virtually, the obstacles grow larger. Written communication can be time consuming and irritating, especially where equations and drawing are essentials. Yet, the proponents of online learning argue that these obstacles can be overcome by employing such techniques as the following:

- ◇ **Instructors' Communications:** Instructors ways of pedagogical instruction may be vital factors for virtual math course success (Belair: 2012). Online math communication is most effective when delivered by instructors not only experienced in their subject matter, but also technologically qualified in teaching online in a web-based environment (Feldman:2005)
- ◇ **Students' Communication:** The development of students' math communication is precise and sophisticated, yet applicable. Since math is conveyed in symbols, students usually do not express a math argument written in online classes; instructors need to coach them on learning how to reflect and participate in math discussions using vocabulary and terminology of the discipline (e.g., terms, symbols) in written forms within technology mediated environments to make their math communication more interactive and collaborative (Ontario Ministry of Education, 2005, p. 23)
- ◇ **Educational Technological Tools (ETT):** Online math courses involve a variety of activities, which require a new ETT tool of pedagogy to transmit the message, where chalks and Wiz IQs are not appropriate. ETT should be available, easy to use, and convenient, to allow students and instructors to reflect upon, clarify and expand their ideas and understand math relationships and math arguments.

In e-learning, most Instructors are judged on how well they are presented, students are more likely to understand, remember, and implement information delivered with the most impact. Presentations are only as good as the instructor. The good news is that regardless the talent level, the effectiveness of communication can be dramatically improved (Mayes: 2014). Online Communication should not be a one-way conversation. Students need a voice if they are to be fully engaged in a course. Online students are more likely to become disengaged from a course if they do not have regular and meaningful communication with both their instructor and fellow students (Bajjalay 2005).

Online mathematical courses at Al-Quds Open University (QOU) are designed to include synchronous and asynchronous instructions. Asynchronous discussion forums are used through the MOODEL, while Wiz IQ served as the synchronous software for the course. Through the discussion forums and the virtual classes, instructors post course documents, assignment directions, and external links on website for students to access remotely. The discussion threads available on the Wiz IQ site provide the online environment for instructors' reflections and feedback on assignments, as well as solving some problems and answering some question raised by students to increase mathematics students' pedagogical content knowledge. Each semester for each math subject, two virtual synchronous class meetings take place, one before the midterms and another before the final exams. Effective math instructions are usually based on using standards-based curricula to enhance mathematics pedagogical content knowledge (Beckmann et al., 2004). Instructors purposefully plan, adapt, and create assignments that are situated within the instructors' classroom practice, or translate to the instructors' classrooms in order to increase students' flexibility in mathematical thinking (Cady, 2007, Wilcox & Jones, 2004). Each of these paradigms is effective in improving student achievements when included in face-to-face instructions. Unfortunately, few have reported using these methods effectively in an online environment. Moreover, studies concerning the use of the internet in math classrooms at higher education level are rare, and there are few studies on the instructors' use of internet with a close physical proximity to the students who are enrolled in the course (Cady:2011).

Mathematics derives much of its power from the use of symbols (Arcavi: 2005). However, researches have shown that their conciseness and abstraction can be barriers to learning (Bardini: 2015); Furthermore, qualitative studies indicate that math does not work well in e-learning (Cady & Hogges: 2011). In this study quantitative and qualitative research methods were used to look beyond mere test scores, to attempt first examining barrier pertaining to math online communication; second, to propose a training program to promote instructors' and students' math communication skills, and finally, to test the effect of the program in overcoming these barriers.

This study took the lead to asses QOU participants within the framework of special training programs on Math Online Communication Skills in order to overcome barriers that participants' face while communicating in online courses.

The Importance of the Study

In online education, students and instructors need well-designed communication to achieve their goals and objectives. Through communication, information, thoughts, and ideas, attitudes and feelings can be shared (Sherwyn, 2008). The better online communication we have, the more effective we are at achieving our hopes and dreams. Based on conversations between the QOU math instructors' and math students' representatives, several issues have been raised from the participants' points of view, concerning online math tools and training which assess interactive communication in an online math courses.

This study is important because it investigates the barriers and challenges that participants face when trying to exchange math concepts that are heavily laden with symbolism, or involve iconic or pictorial representations that are difficult to create and replicate online. The study also suggests solutions for these challenges.

The Purpose of the Study

The current study aims at pointing out the communication barriers that face participants (both students and instructors) in accordance with the nature of the process of online math communication. This study also aims at determining the impact of a math online training program on improving professional online math communication.

The Research Questions

This research addresses the following questions:

- » What are the barriers that participants might face in math online Communication?
- » What impact does the Training Program on Math Communication Skills have on math instructors and students?

Definition of Terms

- ◇ **Communication:** is the ability to share information with people and understand what information and feelings are being conveyed by others. Communication can take many forms including gestures, facial expressions, signs, vocalizations (including pitch and tone), in addition to speech and written communication.
- ◇ **Effective Communication:** involves minimizing potential misunderstanding and overcoming any barriers at each stage of the communication process.

- ◇ **Mathematical Communication:** is related to the expression and organization of ideas and mathematical thinking (e.g., clarity of expression, logical organization), using oral, visual, and written forms, to present data, justify a solution, express a math argument in oral, visual, and written forms, using conventions, vocabulary and terminology of the discipline (e.g., terms, symbols) (Ontario Ministry of Education, 2005, p. 23).
- ◇ In this paper **Mathematical Communication** will be defined as the expression and organization of written mathematical ideas using forms (e.g., pictorial, graphic, dynamic, numeric, algebraic forms; concrete materials), to present data, justify a solution, express a math argument in written forms, using conventions, vocabulary and terminology of the discipline (e.g., terms, symbols)

Methodology

- ◆ **Research Design:** The current study is based on qualitative and quantitative research methods. A multiple choice single-answer survey was distributed to math instructors and students who are enrolled in online math classes at Al-Quds Open University, to investigate the present communication barriers and to identify the skills needed to overcome these barriers. Based on the results of the survey, a training program which included several workshops was conducted to enhance participants' communication skills. Moreover, Naturalistic observations and interviews were conducted to observe the impact of the training program on limiting the math communication barriers among participants. The perceptions of students and instructors provided triangulation, validity and reliability which are needed for the results of the research (Aytekin: 2005)
- ◆ **Population:** The study population consisted of 47 QOU math instructors involved in teaching online math courses, across the 22 branches of Al- Quds Open University, in addition to 23 math students at Al-Quds Branch.
- ◆ **Sample:** The study sample consisted of 23 math QOU instructors who volunteered to participate in the study by answering the questionnaires, and 5 QOU math students who were deliberately chosen based on their availability and capability at Al-Quds Branch.



Instrumentation





- ◆ The survey consisted of ten multiple choice single-answer questions and an open-ended question (See Appendix 1). Two colleagues revised and modified the survey, and some questions were modified to meet the objectives of the research. The survey was distributed at the beginning of the second semester 2012-2013, and was sent to the instructors by e-mail, while distribution to the students was done in person. Participants were asked to provide answers to the questions to discover whether there are any communication barriers regarding math communication via internet. Furthermore, the participants were asked to complete the survey and return it to the researcher within one week.

The researcher requested that the participants to indicate (NP) (not participating) at the top of the survey if they choose not to participate. The inter-questions correlations were significant with Cronbach's Alpha of 0.721.

- ◆ Math Online Communication Skills Training Program (Appendix II) : The program includes:

One day face-to-face training workshop that took place at Open Learning Center (OLC) in the period of mid-January 2012-2013. The workshop was designed to help participants identify immediate communication tactics that they can use in synchronous and asynchronous environments. The workshop provided individual coaching for the sample of the instructors, on implementing and managing various online Wiz IQ Collaboration Tools that appear on the left side of the virtual

classroom window ( Select an item ,  Draw free hand,  Type text using the

keyboard,  Draw a straight line,  Draw a square,  Input an equation ,  The Quiz Manager).

- The participants were also trained on using the interactive online Graphing Calculators, and the math keyboard* that could replace the regular computer keyboard in math e-classes. Additionally, the training included the use of Wolfram math website, which is considered one of the world's most powerful mathematical computation systems, which contains a vast array of original algorithms.
- Four online follow-up work sessions. The purpose of these sessions was to give a chance for the instructors to review and demonstrate math communication skills, and to explore any

difficulties concerning math communication via internet. Each session lasted for 2.5 hours, and consisted of 5 or 6 participants of math instructors who have participated in the training workshop and were led by the researcher.

- One-day face-to-face training workshop for the sample of the students, focused on using the Microsoft Equation, Math Keyboard1, as well as Wolfram alpha website. The workshop took place in January in the academic year 2012- 2013, at Jerusalem Branch's Media Room.
- In February in the academic year 2013-2014, the instructors had a one-day face-to-face workshop, aimed at assisting participants to improve and sustain solid skills of designing and producing short math videos of a high quality, using Camtasia software. The workshop took place at OLC (the whole word).

The researcher conducted naturalistic observations of regular math activities and behaviors that took place in some virtual math classes, course forums, the instructor's portal-page and the participants' portal-pages (See Appendix III).

Face-to-face and e-mail interviews with instructors and students were also conducted and recorded to examine the impact of the training program on their behavior. Participants were asked about their perceptions, opinions, beliefs, and attitudes towards math communication via internet. Their comments were to drive an evolutionary improvement of math communication processes. One of the face-to-face interviews with one of the student participants was for investigating changes occurred after the implementation of the program that was held at Al-Quds Branch. These observations were captured as the sources of evidence.

Data Collection: The questionnaire was distributed to both teachers and students. The researcher requested from the participant instructors to submit the questionnaire online. Only 23 out of 47 questionnaires from the instructors were retrieved. Students were asked to return the survey in person to give them the opportunity to inquire, and to make sure of their capability to participate. 5 out of 23 questionnaires from students were completed and delivered.

* Math Keyboard: It is an ordinary keyboard reprogrammed and designed so that it contained the major symbols a mathematician needs to write a math notation, you can type regular numbers and letters on the standard keyboard and use the (shift+ctrl) to type the mathematical characters (Elsheikh:2013)

Furthermore, numbers were assigned instead of the participants' names to each questionnaire, and SPSS program was used to determine the percentage rate of each answer provided by the participants.

After the completion of the training program, personal observations of math communication that occurred in students' and instructors' forums, and in two virtual classes of online math courses (Calculus I and linear Algebra), were investigated and analyzed in order to evaluate the changes that happened in math communication. Investigation of archival data were captured as sources of evidence and considered in the same manner as information derived from interviews or observations. 23 instructors and 5 students had the opportunity to provide personal perspective by conducting follow-up recorded interviews, to shed the light on various aspects of their communications within the virtual classes. (for recorded interviews see Appendix II)

Limitation of the Study: The study is limited to the communication behavior of the instructors and students who were involved in the online math courses which were conducted in the academic year 2012-2013 and the academic year 2013-2014, and were involved in the math Online Communication Skills Training Program.

Research Findings and Discussions:

The objectives of this study is to identify the barriers students and instructors face in online math communication, and to determine the impact of a training program on improving professional math online communication.

1) Research Findings from Quantitative Data: (Barriers in Math Online communication)

The first question of this study was (What are the barriers that participants face in math online Communication?) To answer this question the frequency and percentage of the survey questions were calculated as shown in the table below.

Table 1

Which of the following resources do you usually exchange and receive most of the math updates scientific course information from?

Item Response	frequency	%
Head of the Math Department	0	0

Item Response	frequency	%
The discussion forums on MOODLE	5	18
Messages through the Portal	12	43
Through the virtual class discussion	7	24
Through my professional personal email	4	14
From the branch announcement wall	0	0

N= 28 (23 instructors and 5 students) (Participants should choose one answer only)

Table 1 shows that the majority of the participants (43%) believed that messages through QOU portal is the major source of information. This indicates that a special care should be given to the messages sent by the Portal. QOU portal actually uses two main contexts: Internet sites and Intranet sites. An Internet site is designed to provide information to the public, while Intranet, helps students, instructors and administrators to collaborate and innovate. It helps facilitate the learning, sharing, and problem solving process by managing news, documents, knowledge, and team discussions inside the university. 24% of the participants assumed that virtual classes are the second major source of information. A virtual classroom is an online learning environment, it is a web-based and accessed through QOU portal. Students in a virtual class participated in synchronous interaction, which means that the instructors and students are logged in the virtual learning environment at the same time. Participants are supposed to use the synchronous communication tools provided by the virtual system effectively and efficiently. 14% of the responses indicated that personal emails are source of information, while 18% of responses indicated to forum discussions through MOODLE as being the source of information.

Online forums discussions have been long used in educational contexts at QOU as part of a broader movement towards online learning. They provide a communication environment in which participants are able to share their views, participate in a dialogue, and learn from each other.

Table 2

Which best describes your impression of communications within online math courses?

Item Response	Frequency	%
Keeps us fully informed	20	71
Keeps us fairly well informed	5	18
Keeps us adequately informed	3	10
Gives us only a limited amount of information	0	0
Doesn't tell us much at all about what is going on.	0	0

N= 28 (23 instructors and 5 students) (Participants should choose one answer only)

Table 2 shows that online communication kept all participants informed to a certain degree. The majority of participants (71%) thought that communication keeps them fully informed. While 18% thought that the online communication course kept them fairly well informed. Only 10% believed that they were adequately informed. Thereby, this requires forming the sent and created messages in a clear understandable approach.

Table 3

How would you rate your math communication skills via internet?

Item Response	frequency	%
Excellent	0	0
Very good	3	11
Good	10	35
Fair	8	29
Poor	7	25

N= 28 (23 instructors and 5 students) (Participants should choose one answer only)

Table3 clearly reveals that participants are in need of improvement of their math communication skills, since 54% of them had either fair or poor online communication skills, while 35% had good skills, and only 11% had very good skills. These results suggests that an urgent solution is needed to improve the participants' math communication skills via internet.

* Three instructors and one student mentioned some personal attempts to do so during the focus group.

Table 4

How do you feel about the information you receive from the sender via internet?

Item Response	frequency	%
I can almost always understand it.	4	14
I can usually understand it.	14	50
I can understand it about half the time.	10	36
I usually can't understand it.	0	0

N= 28 (23 instructors and 5 students) (Participants should choose one answer only)

Table 4 indicates that the information received via internet are generally understood, 14% of the participants stated that they always understand the received message, while 50% said they usually understand it, and the rest (36%) mentioned that half of the time they fail to understand it. Despite the fact that all of the participants are math specialists, results assumes that the sender have failed in one third of the times in getting his message across, surely this might cause a communication breakdown. Consequently, creating roadblocks that stand in the way of the sender goals.

Table 5

The way I express math ideas in e-classes is consistent with the way I use during face-to-face classes.

Item Response	frequency	%
Strongly Agree	0	0
Agree	2	7
Neutral	0	0
Disagree	20	72
Strongly Disagree	6	21

N= 28 (23 instructors and 5 students) (Participants should choose one answer only)

Table 5 clearly shows that there is a difference in the way participants' pass information; and this is due to the environment (conventional face-to-face or web-based) (total of 93%). Only 7% of the participants were consisted in expressing math ideas in both environments. This fact motivated participants to look for new tools to make online teaching and learning experience more interesting and effective*.

Table 6

Overall, how satisfied are you with your communications within math e-leases?

Item Response	Frequency	%
Good	6	7
Satisfied	14	11
Satisfied with some difficulty	3	52
Dissatisfied	4	19
Very dissatisfied	1	11

N= 28 (23 instructors and 5 students) (Participants should choose one answer only)

Table 6 shows that 7 % of participants had good communication in their math online classes, and 11% were satisfied, while the rest were not sure (52%) or dissatisfied (19%) and 11% were very dissatisfied. However, the results showed that despite of all the personal efforts that participant have done to enhance math communication, there is always a need for professional intervention.

Table 7

I feel confident when discuss and reflect on math ideas via email

Item Response	Frequency	%
All the time	1	3
Some of the time	16	57
Undecided	9	33
Almost never	2	7
Never	0	0

N= 28 (23 instructors and 5 students) (Participants should choose one answer only)

Table 7 suggests that a small percentage of participants (3%) expressed their comfort toward using online math communication, while the majority (57%) had some doubts, and 33% couldn't identify their opinion and their attitude. This might be related to the little experience they have, but 7% reported that they never feel comfortable when communicating through internet, which indicates to their true problem or the difficulty they face.

Table 8.

I have the proper tools I need to response to sender.

Item Response	Frequency	%
Strongly Agree	0	0
Agree	0	0
Neutral	0	0
Disagree	22	79
Strongly Disagree	6	21

N= 28 (23 instructors and 5 students) (Participants should choose one answer only)

Table 8 assumes that until the day of the survey's submission, 79% of the participants reported that they didn't have the adequate online tools to convey their thoughts and ideas, while 21% strongly agreed that no adequate tools are available to them.

Table 9.

Major communication obstacles I face during synchronic math classes or discussion (you can choose more than one)

Item Response	frequency	%
Draw graphs	25	90
Write notations and Equations	25	90
The use of different virtual classroom tools (pen and shading) effectively	13	45

N= 28 (23 instructors and 5 students) (Participants should choose one answer only)

Table 9 strongly suggests that math notations and graph during synchronic math classes are considered to be obstacles for 90% of participants, while 45% expressed that it is difficult to use virtual classroom tools such as pen and shading, Graphs, equations, and notations, although they are vital in mathematical language; these tools are used by mathematicians to communicate ideas among themselves. Thus, like in any other language, if terms are misused, the meaning will be misinterpreted.

Table 10

What other obstacles have you faced while dealing with math e-classes? (You can choose more than one)

Item Response	Frequency	%
Suitable math Education software	21	75
Rare of Arabic interactive videos to support the contents	18	65

Item Response	Frequency	%
internet quizzes	25	88
Post applications and send files to the participants during the virtual classes.	18	66

N= 28 (23 instructors and 5 students) (Participants should choose one answer only)

Table 10 recorded some other challenges that participants faced during the math classes based on the internet, such as making online quizzes (88%), inadequate math education software (75%), posting applications and sending files to the participants during the virtual classes (66%), and finally, the lack of Arabic interactive videos to support the contents (65%).

Data obtained from the responses for the open ending question suggested the need for having:

- ◆ Adequate training on online math notation and graphs both in synchronous and asynchronous communication.
- ◆ Training on how to use Wiz IQ tools efficiently in virtual classes.
- ◆ Adequate training on designing instructional videos to support mathematical concepts.

The overall results of the survey indicated that online communication helped participants to be constantly aware of the course educational events. As a result, the messages should be clear and comprehensible. The majority agreed on the fact that using internet as a medium of math communication in education requires different forms of communication compared to the traditional classroom-based instruction. It is presumed that math online communication requires participants to have certain skills. The survey's results have provided an insight into the importance of the second study question.

2) Research Findings from Qualitative Data: Impact of Communication Program.

- » *To answer the second question of the research which is (What Impact does math Communication Skills Training Program have on math instructors and students?)*

The Training Program on Math Online Communication Skills lasted for two months as mentioned earlier. It has provided an individual coaching for the instructors concerning implementing

and managing various online Wiz IQ collaboration tools, as well as math graphing, in addition to creating and designing interactive math videos. The program also introduced a math keyboard that is embedded within the regular computer keyboard to provide quick access to math notations. Instructors were given several practice sessions before the start of the second semester. All of them were assigned to at least one math online course to supervise. All trained students were also involved in one or more online math classes.

Naturalistic observations of regular activities and behavior were conducted for a number of virtual math classes and course forums, the instructor's portal-page and the participants' portal-pages (See appendix II). In addition, face-to-face and online interviews via email with instructors and students were also conducted to examine the impact of the training program on their behavior. They were made to investigate the impact of Training Programs on math online Communication Skills on successfully developing a positive and a professional online communication among participants. Furthermore, the multiple data sources and the methodological notes provided triangulation. Findings could be summarized as follows:

- ***The Impact of the Training Program on Instructors:***

Results were generated from the analysis of the data collected from the online interviews and face-to-face instructors' interviews, in addition to the naturalistic observations of the regular activities and behaviors that took place in three virtual math courses, and forums and the instructors' portal-pages. The results showed that instructors obtained great benefits from the training program. They have progressed and demonstrated better capabilities in overcoming online math communication' barriers. Online math Communication became easier and more accessible. Doubts about online capability for accomplishing tasks, and the ability of sending and receiving vibrant messages were reduced. Moreover, Improvements in expressing math ideas using notations have increased dramatically (See appendix 1). Graphing and drawing online math equation using math Graphical Calculator were observed in several virtual classes. One teacher described his online instructional efforts before and after the training by saying:

(The time demands and logistics of developing math virtual lecture used to suffocate me taking much of my time, -----I used to spend about six hours preparing and planning the content, plus an additional one hour to rehearse, ----- the program is----what I can say---? Led us to save our time and facilitate our work---).

One interviewee thinks that:

(Quick access to math notations and graphs made it possible to write proofs, create diagrams, and highlights certain points in a similar fashion to using chalkboard or white board).

Rapid and immediate feedback regarding students question during virtual classes and through discussion forums were recorded, another teacher expressed his feeling by saying:

(---It is hard to say...how much the results improved the online classroom sessions, ----online instructions started to focus on communicating, rather than lecturing.)

Results also showed that online math instructions for higher-level courses such as (Topology, math analyses, Abstract Algebra ----) worked well, as the math instructions for introductory and basic courses did. One of the interviewee who had positive attitude towards the program reported:

(When I was first asked to teach an online Math course, I had mixed feelings, excited but at the same time worried and tensed -- excited about the new adventure, but worried about using a medium that I knew little about. I joined the interactive discussions offered by the program.I mastered the skill of using PowerPoint presentations to create outlines for my lectures and then upload slides to virtual class. During class, I learned how to fill in the missing parts by writing on the slides or on other blank slides using an interactive pen display).

Number of instructors started designing short videos to support their instruction. Some of them even have YouTube channels. They believe that there is a plethora of educational video resources on any subject and they are available to download from the internet. However, few of those are in Arabic language. Hence, it is vital to be able to create resources as much as needed to support Arabic online instructor. Many instructors tried to individually edit their long instructional films that they have created by themselves in advance with the help of the Media Production Center in QOU. The QOU helped them cut the films to short clips, about 9 minutes long, rather than screening the entire film in one clip.

(Short-bursts videos catch students' attentions, they allow time to be spent on both the introduction of the topic (prior to the viewing) and the dissemination of the key points (post-viewing)).

Many believed that short videos help cover a

lot of ground in the topic in more depth than longer ones, and they stimulate a structured discussion, also they help exploiting time in classrooms in an efficient way, as videos were designed to illustrate important concepts. Videos - as the instructors believe- allow students to reflect and be engaged effectively while watching the educational clips. One of the instructors we observed, was checking all the time the level of students' concentration and focus on the important topics, and remained focused throughout the virtual class. Moreover, he assigned several questions and they were thoroughly discussed, focusing on major key points. He/ She also gave immediate, and constructive feedback. One of the teachers reported:

(What makes online educational videos so great is that it can be watched over and over again for revision, this allows students to watch them in their own time”.

In general, the results of the observations and interviews indicate those Educational videos are helpful to add visual stimuli to lectures. When used properly they can help to enhance the educational experience for students, and raise the level of engagement and achievement during lectures. (BBC: 2010)

• **The Impact of the Training Program on Students**

Summarized transcripts from students' personal interviews, along with observations of activities and behaviors that took place in the three virtual math courses, and forums and the messages which were sent from students to the instructors through the portal-pages, shows that students started “Talking math”. Students were able to communicate their math thinking clearly to their peers and instructors, and used the language of math to express their ideas in a faster and a more efficient Way. According to students, the efficiency of the math keyboard and the math equation software reduced the hours that they used to spend to type math reports or send messages to the instructors. Videos are a convenient solution for the representation of math.

Table 11

demonstrates some changes to the way students communicate using letters such as:(Á,p , D,y ,), figures such as;ñö

(√,π , Δ,ψ ,), figures such as;(√ ≤ , ±, ⊗), symbols expressions such as; ($n \sum_{n=0}^k a^{n-k} x^k$)

compound templates such as; (∫, ∬, ⊕, ≈), and graphs, before and after the training.

Table 11:
Changes to the way students communicate

	Before Training	After Training
Symbols Expressions	find the double integration of x^2 when x goes from 0 to π , and y goes from 0 to 5	Find $\int_0^{\pi} \int_0^5 (\sin x) dx dy$
	Students send attached question in hand writing such as 	Students write through the text in discussion forums, ex: $\lim_{x \rightarrow 1} \frac{x^2 - 4}{x - 2}$ $\sum_1^n \sin^2 \theta$
	Students write math equations and symbols through text using Arabic letters; ex: (الكبش مبرهنت نيس) or (sinc square theta).	Students writing math notation through the text Ex: from discussion forums, and messages to students portal emails $\sin^{-1} \theta$, $\text{csc}^{-1} \theta$
	Students used to describe Matrices by writing the entry rows, ex: a 2×2 matrix First row entries are: 4, 12 Second row entries are: 1, 7	Students use algebraic forms $\begin{bmatrix} 6 & 12 \\ -1 & 0 \end{bmatrix}$
Letters and Figures	X is bigger or equal to minus π and less than π over 5	Students write similar paragraph in virtual $-\frac{\pi}{2} < x \leq \pi$
Graphs	Hand sketched always send as an attachment	Synchronous and asynchronous accurate graphing using wolfram alpha or math equation
Number of Sending Messages	Rare through forums and portals Almost nothing through virtual classes	More frequent (as was deducted by the researcher and the instructors)

Table 11 shows the improvements students demonstrated in using math notations and math symbols' density which is the number of symbols in a mathematical text. For instance, in the first example, out of the 63 symbols, there are 7 characters in the paragraph, giving a symbolic density of 0.11. In the second line, there are 17 symbols in 21 characters, giving a symbolic density of 0.81. The symbolic density reflects the communication improvements students experience (Bardini: 2015). One of the students described the impact of the training program on his math writing skills as follows:

(I used to face difficulties expressing and managing math symbols, at least from the perspective of correctly answering questions posted on course forums, hence, I didn't respond to teachers' requests, I was shy not to express my math thoughts the right way, the problem went deeper and deeper by the time during which math became progressively more densely symbolic. With the technique I learnt from the training, program I started writing math with Style. Although I still have a long way to practice, I think I caught the first step, my responses increased ---).

It was observed that only after few weeks of practicing, students started to show a major progress even in writing math notation, for example, instead of writing "cis θ ". Student A wrote "e^{i θ} ", and instead of writing " $\frac{dx}{dy}$ " Student B wrote " $f'(x)$ " and so on. Although the Choice of either notation is correct, yet the new ones are more used at the university level. When having to work with real intervals, students used to mix words and intervals' notation when answering or discussing problems, for example when student C tried to solve one calculus problem listed on the forum, he wrote "The function increases on the intervals (-1,1) and (1,10)". It seemed that the student C hadn't fully master the intervals' notation. However, few days after training the same student responded to similar calculus problem by writing "The function concave down on" It was also observed that Students were flexibly shift between letters symbol and notations.

Reflections on using short videos: The researcher noticed that instructors started to send videos to their students frequently. Many students believed that these short clips present key concepts in math; they used them to enrich their knowledge in math since they highlighted important mathematical ideas and concepts in an easy and comprehensible visual way. Instructors noticed that with the help of the videos, students were able to make new connections between curriculum topics and the outside world. Videos were frequently watched as data from OLC showed. At later stages, students sent instructors their own comments and reflections on the videos as they concisely asked for more.

Conclusion

As emphasis on math communication in the digital world is growing, educators are eager to find and implement tools that help reform the teaching and learning experience. While the potential value of educational technology tools is high, the way in which tools are implemented can drastically impact the level of the actual communicational value. However, in order for math online communication achieve its maximum potential, it must be harnessed and implemented properly. This requires from the participants to possess a certain set of skills to understand how each tool best support their curricula. Unfortunately, many instructors and students aren't provided with the proper training before enrolling in an online math course.

Based on data collected from quantitative research method, math communication barriers were revealed from the perspective of both students and instructors at QOU. These barriers mainly related to the lack of appropriate mathematical technological tools that are necessary to support the online delivery of context. Furthermore, another challenges is the inability to have effective communication using symbols, graphs and other math notations in virtual classes as they do in face-to-face classes among math instructors and students in online courses. Moreover, Participants emphasized the importance of drawing and writing math notations, equations and expressions - in synchronic and asynchrony environments- in an easy and effective way using a click of one button. The data also shows that participants needed a certain set of skills to understand how various online math tools best support their curricula, since many of them weren't provided with the proper training before implementing the math online course. Participants also strongly believed that there is a need to embrace math videos as a viable form of learning, and as a tool

to improve math teaching and learning. Instructors on the other hand expressed their desire to be trained to create their own short educational videos.

In this perspective, and based on the revealed participants' needs which are gathered from the study questionnaire, a special Training Program on Math Online Communication Skills was created. It aims at creating opportunities for instructors and students to integrate tools in online courses, allowing participants the chance to communicate easily with one another. Moreover, it aims at permitting students to explore and test their comprehension. Feedback resulted from Naturalistic observations and interviews revealed that math keyboard and math sites had a good impact on instructors' teaching methods and on the way they prepare their lessons; they became more efficient as instructors can access math tools properly to save time and efforts. Furthermore, the training enhanced their interactive whiteboards skills, and fostered their communication as well as increased their collaboration.

It was also clear that students overcame some of the math language problems; they got the expertise they needed to write and express their ideas in a clear mathematical language. Training also enabled some of them to think about and articulate what they know in a form of well-organized mathematical paragraphs, they also became more engaged and involved; instructors noticed that their students started to post questions and respond to questions posted on the forums frequently by the end of the training program, one of the instructors commented (my students doing math now not only watching math). Online communication allowed students to become more active participants in the learning process as they comprehended what is being discussed, and organized their thoughts coherently and used carefully constructed language. [8]

The results of the observations and interviews indicated that communication through the use of video was powerful and exciting. Videos became a key component in the online math communication agenda; instructors used videos in their teaching processes predominantly as part of online-based courses. They reported that watching videos helped students to retain more information, comprehend rapidly, and become more enthusiastic.

Finally, this research draw a broader picture for existing online math courses challenges in terms of communication barriers. Math communication skills programs are likely to make a dramatic difference with respect to the mentioned obstacles. The most important lessons learned were that it is necessary to

keep the use of technology as simple as possible while still providing advanced functionalities.

Acknowledgment

I take this opportunity to express gratitude to all QOU Math faculty members and students for their help and support. I also wish to express my sincere thanks to one and all, who directly or indirectly, have lent their hand in this project.

References

1. Arcavi, A.: Developing and Using Symbol Sense in Mathematics. For The Learning of Mathematics, Vol. 25. No. 2. (2005)
2. Aytakin, I.; Fahriye, A. : Communication Barriers: A Study of Eastern Mediterranean University Students' and Teachers' of Online Program and Courses. Turkish Online Journal of Distance Education-TOJDE October ISSN 1302-6488 .Vol. 6. No. 4. (2005)
3. Bajjaly, S.: Enhancing Student, Faculty Communications in Online Courses, Online Journal of Distance Learning Administration, Vol. 9. No. 3. (2005)
4. Bardini, C.& Pierce, R. : Assumed Mathematics Knowledge: The Challenge of Symbols, International Journal of Innovation in Science and Mathematics Education. Vol. No.1.
5. Beckmann et al. (2004): Assisting Students Struggling with Mathematics. Response to Intervention (RtI) for Elementary and Middle Schools. IES PRACTICE GUIDE. The Institute of Education Sciences (IES), national center for education evaluation, NCEE 2009-4060 U.S
6. BBC Active (2010): Education videos: Ten ways to use them well, Educational Publishers, LLP <http://www.bbcactive.com/BBCActiveIdeasandResources/EducationvideosTenwaystousethemwell.aspx> .
7. Betts, K. (2009A): Online Human Touch (OHT) Training & Support: A Conceptual Framework to Increase Faculty Engagement, Connectivity, and Retention in Online Education, Part 2, MERLOT Journal of Online Learning and Teaching, Vol. 5, No. 1. (2015):
8. Betts, K. : Lost in Translation: Importance of Effective Communication in Online Education, Drexel University (2015):

9. Cady, J.; Hodges, J. : The Effects of Virtual Classroom Learning Environments on Middle Grades Mathematics. Teachers' Instructional Practices, RITE Grant Research Report, University of Tennessee, USA (2011):
10. Drouhard, J.; Teppo, A. : Symbols and Language. In K. Stacey, H. Chick, & M. Kendal. (Eds.). The Future of the Teaching and Learning of Algebra: The 12th ICMI Study. Kluwer, Dordrecht. (2004):
11. ElSheikh, R. & Najdi, S. : Math Keyboard Symbols and Its Effect in Improving Communication in Math Virtual Classes, International Journal of Information and Education Technology, Vol. 3, No. 6. (2013):
12. Feldman, R. & Zucker, D. : Teaching and Learning Online Communication, Community, and Assessment. Teaching and Learning Online, University of Massachusetts. (2005):
13. Foster, P. A. : Assessing technology-based approaches for teaching and learning mathematics, International Journal of Mathematical Education in Science and Technology, Vol. 37, No. 2. (2006):
14. Foster, P. : Assessing technology-based approaches for teaching and learning mathematics, International Journal of Mathematical Education in Science and Technology, Vol. 37, No. 2. (2004).
15. Glenn, S. & Ferguson, D. Student attrition in mathematics e-learning, Australasian Journal of Educational Technology, Vol. 21. No.2. , (2005).
16. Hamer, B. : Communication Within The workplace, Master of Science Degree in Training and Development, University of Wisconsin-Stout, USA. , (2005).
17. Schmitz, A. : Introduction to Group Communication (v. 0.0), (<http://lardbucket.org>) , (2012).
18. Just, G. : The effect of online interactive visuals on undergraduate mathematics learning. Ph.D. thesis, Northern Illinois University. , (2010).
19. Mayes, R. : Chapter in Principles of Effective Teaching, Mathematics On-line: A Virtual Reality or Impossibility. Vol.12. No 4 , (2014).
20. Mojibur, R. (2010): Teaching Oral Communication Skills: A Task-based Approach, ESP World. Issue 1. Vol. 27. No. 9.
21. Ontario Ministry of Education. The Ontario Curriculum, Grades 1 to 8: Mathematics. Toronto, ON: Queen's Printer for Ontario (2005).
22. Ontario Ministry of Education.: Problem solving and communication. A guide to effective instruction in mathematics, Kindergarten to grade 6: Vol. 2. (2006).
23. Ontario Schools: Communication in the Mathematics Classroom, Capacity Building Series, ISSN: 1913 8490 , (2010):
24. Portela, J. : Communicating mathematics through the internet: A case study, Interactive Educational Multimedia. Vol. 14. (2007).
25. Sherwyn, P; Judy, C. : Why Communication Education is Important: The Centrality of the Discipline in the 21st Communication Education .Vol. 57, No. 2. (2008):
26. Smith, G.; Ferguson, D. , Student attrition in Mathematics e-learning, Australian Journal of Educational Technology, Vol 31, No 3 , (2005).
27. Smith, G.; Ferguson, D. . Diagrams and Math Notation in E-Learning: Growing Pains of a New Generation, International Journal of Mathematical Education in Science and Technology. Vol. 35. No 5. , (2004).
28. Stahl, G. , Enhancing Mathematics Communication for Virtual Team, Acta Didactica Napocensia. Vol5, No. 2 , (2010).
29. World Bank., Information and Communications for Development: Maximizing Mobile. , (2012).